

Intelligent Voltage/Ampere Meter User Manual



Features:

1. One meter support 3 input ranges maximum.
2. With measurement display, alarm output, analog output, communication etc.
3. Two DI input and two DO output functions are available.
4. This product is used for voltage or current monitoring in industrial machinery, machine tools and related equipment.
5. AC and DC effective value measurement, polarity display can be selected for DC measurement.
6. Economical and practical, easy to operate.

The instruction,for DWL series Voltage/Ampere Meter, explain instrument settings, connections,name and etc, please read carefully before you use the temperature controller. Please keep it properly for necessary reference.

I. Safe Caution

Warning

- 1) When the failure or abnormal of products lead to a system of major accidents,please set the proper protection circuit in the external.

National High-tech Enterprise/ National Standard Drafting Unit



Hotline: 400-0760-168

KKDLW-A01E-A0-20220712

- g. where has air conditioning or heating of air blowing directly to the site
- h. where will be illuminated directly by sunlight
- i. where accumulation of heat will happen caused by radiation.

- 4) For installation occasions, please consider the following points before installation.

- a. In order to protect heat saturated, please ensure adequate ventilation space.
- b. Please consider connections and environment,and ensure that the products below for more than 50mm space.
- c. Please avoid to installed over the machine of the calorific value(Such as heaters, transformer,semiconductor operations, the bulk resistance).
- d. When the surrounding is more than 50°C, please using the force fan or cooling fans. But don't let cold air blowing directly to the product.
- e. In order to improve the anti - interference performance and security, please try to stay away from high pressure machines, power machines to install.
- f. Don't install on the same plate with high pressure machine and the product.
- g. The distance should be more than 200mm.
- h. Please install the power machine as far as possible.

2. Cable caution:

- 1) This product is a single-channel measuring instrument, each instrument can only accept one measurement signal input, and the unused channel should not be connected to the wire.
- 2) In the high voltage or current measurement circuit, the instrument should be input with the appropriate PT or CT ratio; the necessary fuse, voltage open circuit, open circuit, current short circuit, and open contact should be added to the instrument input front end circuit.
- 3) In order to avoid the effect of noise, please put the input signal away from meter cable, power cable, load cable to wiring.
- 4) In order to reduce the power cables and the load power cables on the effect of this product, please use noise filter in the place where easy to effect.You must install it on the grounding of the disk if you use the noise filter,and make the wiring to be shortest between noise filter output side and power connectors.Don't install fuse and switch on the wiring of noise filter output side,otherwise it will reduce the effect of noise filter.
- 5) It takes 5s from input power to output.
- 6) Please use twisted pair with a shield for analog output line,to ensure the reliability of signal, if necessary.
- 7) Please use twisted pair with a shield for remote RS485 communication cable,and deal with the shield on the host side earth, to ensure the reliability of signal.
- 8) This product don't have the fuse; please set according to rated voltage 250V, rated current 1A if you need; fuse type:relay fuse.
- 9) Please use the suitable screw force and crimp terminal.
 The screw terminal size: M3X8 (with 6.8X6.8 square base)
 Recommended tightening torque: 0.4N.m
 Proper cables: 0.25 ~ 1.65mm single cable/multiple core cable
- 10) Please don't put the Crimp terminal or bare wire part contact with adjacent connector.

II. Model Illustration

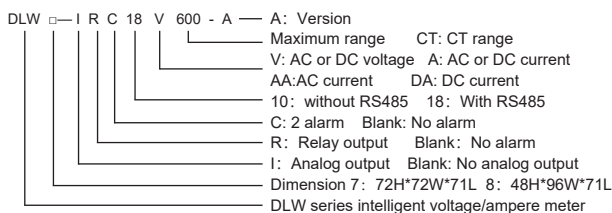

- 2) Please don't plug in before completing all the wire.Otherwise it may lead to electric shock, fire, fault.
- 3) Not allow to use outside the scope of product specification,otherwise it may lead to fire,fault.
- 4) Not allow to use in the place where is inflammable and explosive gas.
- 5) Do not touch power terminal and other high voltage part when the power on,otherwise you may get an electric-shock.
- 6) Do not remove,repair and modify this product,otherwise it may lead to electric shock, fire, fault.

Caution

- 1) The product should not be used in a nuclear facility and human life associated medical equipment.
- 2) The product may occur radio interference when it used at home.You should take adequate countermeasures.
- 3) The product get an electric shock protection through reinforced Insulation. when the product is embedded in the devices and wiring,please subject to the specification of embedded devices.
- 4) In order to prevent surge occurs,when using this product in the place of over 30m indoor wiring and wiring in outdoor,you need to set the proper surge suppression circuitry.
- 5) The product is produced based on mounting on the disk.In order to avoid to touch the wire connectors,please take the necessary measures on the product.
- 6) Be sure to observe the precautions in this manual, otherwise there is a risk of a major injury or accident.
- 7) When wiring, please observe the local regulation.
- 8) To prevent to damage the machine and prevent to machine failure, the product is connected with power lines or large capacity input and output lines and other methods please install proper capacity fuse or other methods of protection circuit.
- 9) Please don't put metal and wire clastic mixed with this product,otherwise it may lead to electric shock, fire, fault.
- 10) Please tighten screw torque according to the rules.If not,it may lead to electric shock and fire.
- 11) In order not to interfere with this products to dissipate heat, please don't plug casing around the cooling vent hole and equipment.
- 12) Please don't connect any unused terminal.
- 13) Please do the cleaning after power off, and use the dry cleaning cloth to wipe away the dirt. Please don't use desiccant, otherwise, it may casue the deformation or discoloration of the product.
- 14) Please don't knock or rub the panel with rigid thing.
- 15) The readers of this manual should have basic knowledge of electrical,control, computer and communications.
- 16) The illustration, example of data and screen in this manual is convenient to understand,instead of guaranteeing the result of the operation.
- 17) Regular maintenance is necessary for long-term safe use of this product. Some parts of this product are subject to life restrictions, and some may change due to long-term performance.
- 18) The contents of the manual may be changed without prior notice. If there is any questions or objections, please contact us.

Caution of Installation & Connection

- 1) This product is used in the following environmental standards.
 (IEC61010-1) [Overvoltage category II, class of pollution 2]
- 2) This product is used in the following scope:surrounding environment, temperature, humidity and environmental conditions.Temperature: 0 ~ 50°C; Humidity: 45 ~ 85%RH; Environment condition: Indoor warranty,The altitude is less than 2000m.
- 3) Please avoid using in the following places:
 - a. will be dew for changing temperature
 - b. with corrosive gases and flammable gas;
 - c. with vibration and impact
 - d. with water, oil, chemicals, smoke and steam facilities
 - e. with dust, salt, metal powder
 - f. with clutter interference, static electric, magnetic fields and noise

III. Model

Model	Alarm output	Analog output	RS485 communication	DI	Input range
DLW□-IRC18V600	2 alarms	4~20mA	Yes	Yes	IN1:6V,IN2:60V,IN3:600V
DLW□-IRC18V200	2 alarms	4~20mA	Yes	Yes	IN1:2V,IN2:20V,IN3:200V
DLW□-IRC18V100	2 alarms	4~20mA	Yes	Yes	IN1:1V,IN2:10V,IN3:100V
DLW□-IRC18A2	2 alarms	4~20mA	Yes	Yes	IN1:2A,IN2:0.2A,IN3:0.02A
DLW□-IRC18AACT	2 alarms	4~20mA	Yes	Yes	IN1:AC 5A
DLW□-IRC18DACT	2 alarms	4~20mA	Yes	Yes	IN1:75mV
DLW□-RC10V600	2 alarms	No	No	No	IN1:6V,IN2:60V,IN3:600V
DLW□-RC10V200	2 alarms	No	No	No	IN1:2V,IN2:20V,IN3:200V
DLW□-RC10V100	2 alarms	No	No	No	IN1:1V,IN2:10V,IN3:100V
DLW□-RC10A2	2 alarms	No	No	No	IN1:2A,IN2:0.2A,IN3:0.02A
DLW□-RC10AACT	2 alarms	No	No	No	IN1:AC 5A
DLW□-RC10DACT	2 alarms	No	No	No	IN1:75mV
DLW□-V600	No	No	No	No	IN1:6V,IN2:60V,IN3:600V
DLW□-V200	No	No	No	No	IN1:2V,IN2:20V,IN3:200V
DLW□-V100	No	No	No	No	IN1:1V,IN2:10V,IN3:100V
DLW□-A2	No	No	No	No	IN1:2A,IN2:0.2A,IN3:0.02A
DLW□-AACT	No	No	No	No	IN1:AC 5A
DLW□-DACT	No	No	No	No	IN1:75mV
DLW□-IAACT	No	4~20mA	No	No	IN1:AC 5A

IV. Technical Specification

Power Supply	100 ~ 240V AC/DC (85-265V)
Accuracy	(counting more than 2000) ± 0.5% F.S ± 3 digits @ 25±3 degrees, and the measured temperature drift is less than 500ppm
Resolution	Default range minimum unit display value of or 12bits
AC frequency	Hz range: 45 ~ 400Hz Accuracy guarantee range: 50~100Hz
Relay capacity	AC 250V /1A rated load life > 100000 times
Power consumption	< 6VA
Ambient condition	Indoor use, 0 ~ 50°C without condensation, humidity: < 85%RH, altitude<2000m
Storage environment	-10 ~ 60°C, no condensation
Switch input	Passive dry contact input
Current output	DC 4~20mA Load<500Ω Temperature drift 300PPM
Comm. port	RS485 interface, Modbus-RTU protocol, connect up to 30 units max
Insulation resistance	Input, output, power supply to the case > 20MΩ
Electrostatic discharge	IEC/EN61000-4-2 Contact ±4KV /Air ±8KV perf.Criteria B
Pulse group immunity	IEC/EN61000-4-4 ±2KV perf.Criteria B
Surge immunity	IEC/EN61000-4-5 ±2KV perf.Criteria B
Voltage sag&short-term interruption immunity	IEC/EN61000-4-29 0% ~ 70% perf.Criteria B

Isolation voltage	Signal input, output, power: 2000VAC 1min
Total weight	About 400g
Cover material	The shell and panel frame PC/ABS(Flame Class UL94V-0)
Panel material	PC mirror and PEM silicone key
Power failure memory	10 years, data can be written 1 million times
Panel Protection level	IP65(IEC60529)
Safety Standard	IEC61010-1 Overvoltage category II , pollution level 2, level II (Enhanced insulation)

3) Isolation mode diagram:

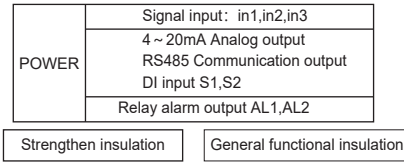

V. Panel Instruction

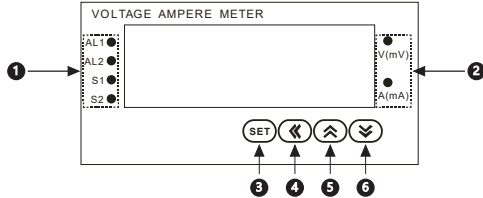

No.	Symbol	Name	Function
1	AL1	AL1 indicator light	1st alarm(DO) indicator light, there is alarm(DO) output when it is on, no alarm(DO) output when it is off
	AL2	AL2 indicator light	2nd alarm(DO) indicator light, there is alarm(DO) output when it is on, no alarm(DO) output when it is off
	S1	S1 indicator light	1st switching value S1(DI1) indicator light, there is S1(DI1) input when it is on, there is no input when it is off
	S2	S2 indicator light	2nd switching value S2(DI2) indicator light, there is S2(DI2) input when it is on, there is no input when it is off
2	V (mV)	V(mV) unit indicator light	Voltage unit indicator light, the unit is V when it is normally on, the unit is mV when it is flashing.
	A (mA)	A(mA) unit indicator light	Current unit indicator light, the unit is A when it is normally on, the unit is mA when it is flashing.
3	SET	SET key	Menu key/ confirm key, used to enter or exit parameter modification mode, or confirm/save modified value.
4	←	Shift key	Activate key/ parameter checking key/ shift key to modify parameter
5	→	Add key	Increase key, used to increase parameter value
6	↓	Reduce key	Decrease key, used to decrease parameter value

4/12

2) Menu:

No.	Name	Illustration	Setting range	Factory set
1	INP	Input channel & range selection, 0(IN1): 1st channel, 1(IN2): 2nd channel, 2(IN3): 3rd channel. Corresponding communication code 0~2. Set this parameter to select corresponding physical range.	0~2	
2	MET	Measurement & display type selection 0(AC): used to measure AC voltage or current. 1(DC): used to measure DC voltage or current. Communication code: 0~1.	0~1	AC
3	AL1	1st alarm value	-1999~9999	90%FS
4	HY1	1st alarm hysteresis	0~9999	10
5	AD1	1st alarm mode 0(NO): No alarm output. When it is set as this mode, alarm function does not work; alarm relay is used for 1st switch output, DO1 output. 1(H): High limit alarm output. When it is set as this mode, and PV≥AL1; if ALT1=0, alarm outputs immediately; if ALT1≠0, alarm outputs when delay time is over. 2(L): Low limit alarm output. When it is set as this mode, and PV<AL1; if ALT1=0, alarm outputs immediately; if ALT1≠0, alarm outputs when delay time is over. 3(ODE): Beyond deviation interval alarm output. When it is set as this mode, and PV≤AL1-HY1 or PV≥AL1+HY1; if ALT1=0, alarm outputs immediately; if ALT1≠0, alarm outputs when delay time is over; otherwise, cancel alarm output. 4(IDE): Among deviation interval alarm output. When it is set as this mode, and AL1-HY1≤PV≤AL1+HY1; when ALT1=0, alarm outputs immediately; when ALT1≠0, alarm outputs when delay time is over; otherwise, cancel alarm output. Refer to "Note1" for output logic diagram. PV is measured value. The corresponding communication code for NO, H, L, ODE, IDE is 0~4.	0~4	H
6	ALT1	1st alarm delay time or DO1 output time, this value is without decimal point. Unit: second	0~9999	0
7	AL2	2nd alarm value	-1999~9999	10%FS
8	HY2	2nd alarm hysteresis	0~9999	10

6/12

VI. Operation process & menu illustration

1) Operation process diagram

Measuring & control mode

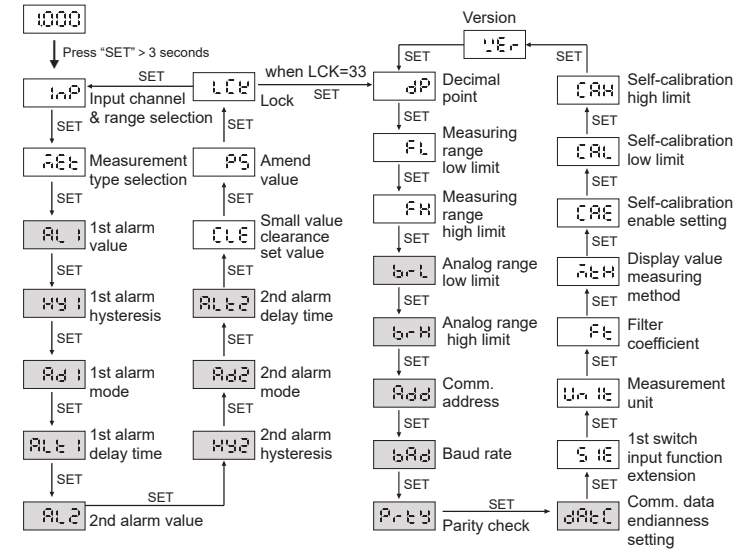

Note: The shaded part of the menu will be hidden when there is no such function.

- After power on, in the normal measurement control interface, keep pressing "SET" key more than 3 second to enter the menu parameter view mode.
- In the menu view mode, press the "SET" key to cycle display the regular menu. Press " " or " " key to return to last menu or move forward to next menu.
- In the menu name display interface, press the " " key to view the menu parameter value, then short press this key to flash the parameter value and enter the parameter modification mode, each short press of this key can move one digit to the left in cycle.
- In the parameter modification mode, press " " or " " key once to add or reduce "1" to the flashing data.
- In the parameter modification mode, after the modification, press "SET" to save the modified parameter, press it one more time to return back to menu view mode.
- In the menu view mode or parameter modification mode, keep pressing "SET" key more than 3 second to exit current mode and return to normal measurement control interface.

5/12

Continue

9	AD2	2nd alarm mode 0(NO): No alarm output. When it is set as this mode, alarm function does not work; alarm relay is used for 2nd switch output, DO2 output. 1(H): High limit alarm output. When it is set as this mode, and PV≥AL2; if ALT2=0, alarm outputs immediately; if ALT2≠0, alarm outputs when delay time is over. 2(L): Low limit alarm output. When it is set as this mode, and PV<AL2; if ALT2=0, alarm outputs immediately; if ALT2≠0, alarm outputs when delay time is over. 3(ODE): Beyond deviation interval alarm output. When it is set as this mode, and PV≤AL2-HY2 or PV≥AL2+HY2; if ALT2=0, alarm outputs immediately; if ALT2≠0, alarm outputs when delay time is over; otherwise, cancel alarm output. 4(IDE): Among deviation interval alarm output. When it is set as this mode, and AL2-HY2≤PV≤AL2+HY2; when ALT2=0, alarm outputs immediately; when ALT2≠0, alarm outputs when delay time is over; otherwise, cancel alarm output. Refer to "Note1" for output logic diagram. PV is measured value. The corresponding communication code for NO, H, L, ODE, IDE is 0~4.	0~4	L
10	ALT2	2nd alarm delay time or DO2 output time, this value is without decimal point. Unit: second	0~9999	0
11	CLE	Small value clearance set value, if the absolute value of PV is less than this value, PV return to zero.	0~1000	0
12	PS	Amend value. Non polar measurement or positive polarity, display value = actual measured value + amend value. Negative polarity, display value = actual measured value - amend value.	-1999~9999	0
13	LCK	Lock function. 0010: menu set value can be checked only, cannot be modified. 0033: enter the advanced menu.	0~9999	0
14	DP	Decimal point. 0: 0.000 1: 0.00 2: 0.00 3: 0.000 Note: setting or changing the decimal point will affect the alarm set value and display value; after modification, the corresponding set value should be adjusted.	0~3	
15	FL	Measuring range low limit. When the meter is used for voltage and current measurement, please keep this value at 0. Note: this set value must be less than the measuring range high limit.	-1999~9999	0

7/12

Continue

16	FH	Measuring range high limit. Modify this value to change the display value high limit. Oftenly used for CT input measurement. For example, the input current of the instrument is AC 5A, the normal display should be 5.00, but if this value is changed to 200.0, the measuring range will be changed to 200A: 5A. Note: this set value must be larger than measuring range low limit.	-1999~9999	100% FS
17	BRL	Analog range low limit. It is used to set the measurement low limit of the analog output, its default value is equal to the set value of measuring range low limit, when there is no special application. When this value is larger than analog range high limit, it is reverse analog output.	-1999~9999	0
18	BRH	Analog range high limit. It is used to set the measurement high limit of the analog output, its default value is equal to the set value of measuring range high limit, when there is no special application. When this value is less than analog range low limit, it is reverse analog output.	-1999~9999	100% FS
19	ADD	RS485 communication address, set the physical address of this equipment	0~255	1
20	BAD	RS485 communication baud rate 0(4.8): 4800; 1(9.6): 9600; 2(19.2): 19200.	0~2	9.6
21	PRTY	RS485 parity check setting 0(NO): No check 1(ODD): Odd check 2(EVEN): Even check	0~2	0
22	DATC	RS485 communication data endianness setting. Communication data transport sequence setting 0000; 1st & 2nd bit function reserved; 3rd bit is endianness exchange; 4th bit function reserved.	0~9999	0
23	S1E	1st Switch Input function extension. 0(DI): For switch input 1(HOLD): Hold function input 2(MAX): Hold maximum value function input 3(MIN): Hold minimum value function input	0~3	DI
24	UNIT	Measurement unit: 0(NO): No unit indicator. 1(V): Unit "V" indicator light is on. 2(mV): Unit "mV" indicator light flashes. 3(A): Unit "A" indicator light is on. 4(mA): Unit "mA" indicator light flashes. Corresponding communication code : 0~4.	0~4	Base on the meter model

8/15

VII. Operation for Self-calibration

- 1) Set INP input channel.
- 2) Add the input signal to the correct input channel.
- 3) Enter the low limit calibration menu CAL, press "<<" to flesh "YES"; meanwhile, adjust the input signal to the minimum value and input it to the meter.
- 4) When "YES" is fleshing and the minimum signal has been inputted to the meter, press "SET" key to confirm and save the calibration value.
- 5) After the low limit calibration has been done, enter the high limit calibration menu CAH, press "<<" to flesh "YES".
- 6) Adjust the input signal to the maximum value and input it to the meter. When "YES" is fleshing, press "SET" key to confirm and save the calibration high limit value.
- 7) After the calibration is done, enter the menu CAE to change "N" to "Y" to enable the calibration value; otherwise, the meter will still use the default value.
- 8) The calibrated high low limit value of the linear signal should not exceed $\pm 10\%$ of the input standard value range.
- 9) After the calibration, if the result is not satisfied, the meter can be calibrated again.

VIII. Dimension & Panel cutout

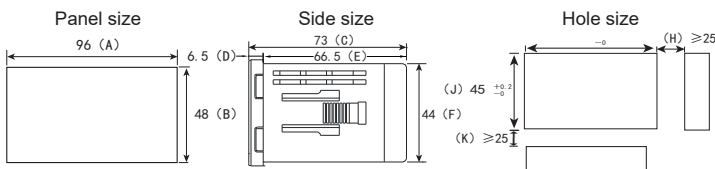

Model	A	B	C	D	E	F	G	H(Min)	J	K(Min)
7:(72*72)	72	72	71	6.5	64.5	67	67	25	67.5	25
8:(96*48)	96	48	73	6.5	66.5	44	92	25	45	25

IX. Wiring Diagram

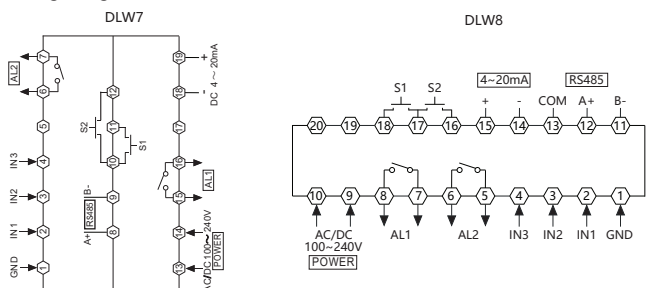

Note: please subject to the diagram on the product if any changes.

10/15

Continue

25	FT	Filter coefficient. The larger the value, the stronger the filter function. Can be applied to the occasion of large fluctuation measurement.	0~2000	0
26	MTH	Display value measuring methods. 0(RMS): Effective value measurement; 1(AVG): Average measurement	0~1	RMS
27	CAE	User self-calibration enable function. Y: Enable the self-calibration parameters; N: Do not use the self-calibration parameters.	Y/N	N
28	CAL	Self-calibration low limit input. After add the low end signal to the signal input terminal, flash YES to activate, after confirm and display OK, the input signal low end calibration is completed.	YES/OK	YES
29	CAH	Self-calibration high limit input. After add the high end signal to the signal input terminal, flash YES to activate, after confirm and display OK, the input signal high end calibration is completed.	YES/OK	YES
30	VER	Software version	--	--

Note 1: Alarm mode and output logic diagram:

Illustration: "☆" ATL1 or ATL2 delay time, "▨" alarm output.

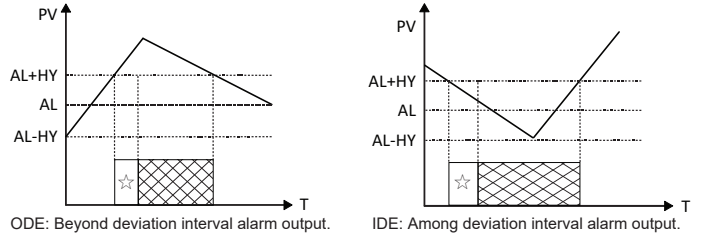
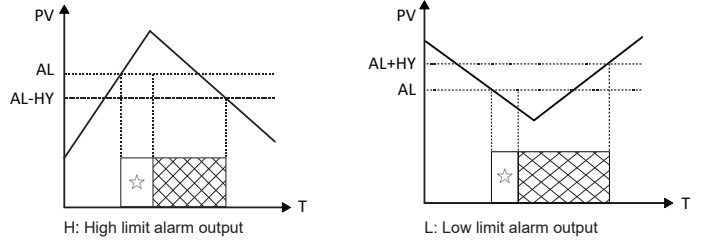

9/15

X. Checking methods of simple fault

Display	Checking methods
HHHH	It means the input signal exceeds the measuring range. Please confirm whether the measured signal is within the range of the instrument; otherwise, the instrument will be damaged.

XI. Communication Protocol

The meter uses Modbus RTU communication protocol, carries out RS485 half-duplex communication, read function code 0x03, write function code 0x10 or 0x06, uses 16-bit CRC check, the meter does not return error check. The communication data type is 16bit integer data (short int), positive numbers are represented by the true form, and negative numbers are represented by the complement; each data seizes one register. The position of the decimal point is determined by the DP parameter, which must be confirmed when processing the data. For example: when DP is 1, the read setting parameter should be divided by 10, then there is one decimal place, and there are three decimal places at most. Note that there is no decimal for setting selection function parameters. Reading data cannot exceed 125 registers at a time, the meter returns 0 for invalid register data. Writing data cannot exceed 4 registers at a time. When there is a data error in the write data packet, an error response will be returned. The communication writing register should not be too frequent, and the data can be written up to 1 million times.

Note:

1. Whether the meter supports the comm. function and is connected to the host correctly, and whether the host supports the corresponding comm. protocol.
2. Whether the meter address ADD is the only value in the comm. link.
3. Whether the baud rate BAD and parity PRTY are consistent with the host.
4. Whether the host communication sending and receiving cycle time is sufficient, and whether the data type analysis is correct.

Data frame format:

Start bit	Data bit	Check bit	Stop bit
1	8	Set in Menu PRTY	1

Handling of abnormal communication:

When abnormal response, put 1 on the highest bit of function code. For example: Host request function code 0x03, then slave response function code should be 0x83.

Error code:

- 0x01--- Illegal function: the function code sent from host is not supported by meter.
- 0x02--- Illegal address: the register address designated by host beyond the address range of meter.
- 0x03--- Illegal data: Date value sent from host exceeds the corresponding data range of meter.

Communication cycle:

Communication cycle is the time from host data request to slave data response, i.e.: communication cycle = host request data sending time + slave preparation time + response delay time + response return time

Example: 9600 baud rate: communication cycle of single measured data ≥ 250 ms.

11/15

1. Read Multiple Registers

For example: Host read integer AL1 (alarm value 1800)

The address code of AL1 is 0x4002, because AL1 is integer (2 byte), it seizes 1 data register. The memory code of decimal integer number 1800 is 0x0708.
 Note: When reading data, read DP value or confirm DP menu value to determine the decimal point position first, and then convert the read data to get the actual value. On the contrary, before writing the data, the data should be converted to the corresponding rate before writing the data to the meter.

Host request (Read multi-register)							
1	2	3	4	5	6	7	8
Meter address	Function code	Start Address high bit	Start Address low bit	Data byte length high bit	Data byte length low bit	※CRC code low bit	※CRC code high bit
0x01	0x03	0x40	0x02	0x00	0x01	0x30	0x0A
Slave normal answer(Read multi-register)							
1	2	3	4	5	6	7	
Meter address	Function code	Data byte number	Data high bit	Data low bit	※CRC code low bit	※CRC code high bit	
0x01	0x03	0x02	0x07	0x08	0xBB	0xB2	

Function code abnormal answer: (For example: host request address is 0x2010)

Slave abnormal answer(Read multi-register)				
1	2	3	4	5
Meter Address	Function code	Error code	※CRC code low bit	※CRC code high bit
0x01	0x83	0x02	0xC0	0xF1

2. Write Multi-register

For example: Host write integer AL1 (alarm value 1500)

The address code of AL1 is 0x4002, because AL1 is integer (2 byte), seizes 1 data register. The hexadecimal memory code of decimal integer number 1500 is 0x05DC.

Host request (Write multi-register)										
1	2	3	4	5	6	7	8	9	10	11
Meter address	Function code	Start address high bit	Start address low bit	Data byte length high bit	Data byte length low bit	Data byte length	Data high bit	Data low bit	※CRC low bit	※CRC high bit
0x01	0x10	0x40	0x02	0x00	0x01	0x02	0x05	0xDC	0xE4	0xBF
Slave normal answer(write multi-register)										
1	2	3	4	5	6	7	8			
Meter address	Function code	Start address high bit	Start address low bit	Data byte length high bit	Data byte length low bit	※CRC code low bit	※CRC code high bit			
0x01	0x10	0x40	0x02	0x00	0x01	0xB5	0xC9			

12/15

Continue

19	0x4103 (416644)	1st Alarm Mode AD1	1	R/W	
20	0x4104 (416645)	2nd alarm mode AD2	1	R/W	
21	0x4105 (416646)	1st switch output DO1	1	R/W	1: close, 0: open
22	0x4106 (416647)	2nd switch output DO2	1	R/W	1: close, 0: open
23	0x4107 (416648)	1st switch input function extension S1E	1	R/W	
24	0x4108 (416649)	Unit UNIT	1	R/W	
25	0x4109 (416650)	Meter address ADD	1	R/W	
26	0x410A (416651)	Baud rate BAD	1	R	
27	0x410B (416652)	Parity check PRTY	1	R	Note ③
28	0x410C (416653)	Endianness setting DATC	1	R	
29	0x410D (416654)	Lock LCK	1	R	
30	0x410E (416655)	Meter panel status STATUS	1	R	Note ②
31	0x410F (416656)	Meter name	1	R	

Note ①: The register number is to convert the address to decimal and add 1, and then add the register identification code 4 to the front. For example: the register number of the data address 0x4000 is 16384+1=16385 and 4 is added to the front, which is the register number 416385. For related application, please refer to Siemens PLC S7-200.

Note ②: Channel status indicator, when the data bit is 1, it means execution; when it is 0, it means no execution.

D7	D6	D5	D4	D3	D2	D1	D0
			HHHH	S2	S1	AL2	AL1

Note③: DTC communication data transmission sequence description

DTC: □ □ □ Reserve
 — Byte transfer order: 0: the transfer order is 1, 2.
 — Reserve 1: the transfer order is 2, 1.

Host write single register AL1 (alarm value 1500)

Host request (Write single register)							
1	2	3	4	5	6	7	8
Meter address	Function code	Address high bit	Address low bit	Data high bit	Data low bit	※CRC low bit	※CRC high bit
0x01	0x06	0x40	0x02	0x05	0xDC	0x3F	0x03
Slave normal answer(write single register)							
1	2	3	4	5	6	7	8
Meter address	Function code	Address high bit	Address low bit	Data high bit	Data low bit	※CRC low bit	※CRC high bit
0x01	0x06	0x40	0x02	0x05	0xDC	0x3F	0x03

Data value error response (Example: host request write address index is 0x4002)

Slave abnormal answer (write multi-register)				
1	2	3	4	5
Meter address	Function code	Error code	※CRC code low bit	※CRC code high bit
0x01	0x90	0x03	0x0C	0x01

Meter parameters address mapping table

No.	Address (Register No. Note①)	Variable name	Register	R/W	Remark
1	0x4000 (416385)	Measured value PV	1	R	
2	0x4001 (416386)	Decimal point DP	1	R/W	
3	0x4002 (416387)	1st alarm value AL1	1	R/W	
4	0x4003 (416388)	1st alarm hysteresis HY1	1	R/W	
5	0x4004 (416389)	1st alarm delay time ALT1	1	R/W	
6	0x4005 (416390)	2nd alarm value AL2	1	R/W	
7	0x4006 (416391)	2nd alarm hysteresis HY2	1	R/W	
8	0x4007 (416392)	2nd alarm delay time ALT2	1	R/W	
9	0x4008 (416393)	Display low limit FL	1	R/W	
10	0x4009 (416394)	Display high limit FH	1	R/W	
11	0x400A (416395)	Analog output low limit BRL	1	R/W	
12	0x400B (416396)	Analog output high limit BRH	1	R/W	
13	0x400C (416397)	Filter coefficient FT	1	R/W	
14	0x400D (416398)	Amend value PS	1	R/W	
15	0x400E (416399)	Small value clearance CLE	1	R/W	
Reserve					
16	0x4100 (416641)	Input channel INP	1	R/W	
17	0x4101 (416642)	Measurement type MET	1	R/W	
18	0x4102 (416643)	Measurement method MTH	1	R/W	

13/15

※16-bit CRC check code to get C program

```

unsigned int Get_CRC(uchar *pBuf, uchar num)
{
    unsigned int i,j;
    unsigned int wCrc = 0xFFFF;
    for(i=0; i<num; i++)
    {
        wCrc ^= (unsigned int)(pBuf[i]);
        for(j=0; j<8; j++)

            if(wCrc & 1){wCrc >>= 1; wCrc ^= 0xA001;}
            else
                wCrc >>= 1;
    }
    return wCrc;
}
    
```