

Intelligent Temperature Controller User Manual

For TP-D Version



Features

- Multi input signal and multi models for option.
- With measured display, control output, alarm output, analog output, RS485 communication, etc.
- Multi PID algorithms for option, with auto tune function.
- This product can be used in industrial machinery, machine tools, general measuring instruments and equipment.

National High-tech Enterprise/ National Standard Drafting Unit



Hotline: 400-0760-168

Version code: KKTP-D01E-A/1-20231109

The instruction explain instrument settings, connections, name and etc, please read carefully before you use the temperature controller. Please keep it properly for reference when necessary.

⚠ Electric-shock

- 1) Please don't plug in before completing all the wire. Otherwise it may lead to electric shock, fire, fault.
- 2) Don't touch power terminal and other high voltage part when the power on, otherwise you may get an electric-shock.
- 2) Don't remove, repair and modify this product, otherwise it may lead to electric shock, fire, fault and electrical Danger

⊘ Forbiddance

- 1) Not allow to use outside the scope of product specification, otherwise it may lead to fire, fault.
- 2) Don't use it in places with flammable and explosive gases.
- 3) This product should not be used in atomic energy equipment and medical devices related to human life.

ⓘ Attention

- 1) When the failure or abnormality of this product may lead to serious system accidents, please set proper protection circuits in the external.
- 2) The product may occur radio interference when it used at home. You should take adequate countermeasures.
- 3) The product get an electric shock protection through reinforced Insulation. When the product is embedded in the devices and wiring, please subject to the specification of embedded devices.
- 4) In order to prevent surge occurs, when using this product in the place of over 30m indoor wiring and wiring in outdoor, you need to set the proper surge suppression circuitry.
- 5) The product is produced based on mounting on the disk. In order to avoid to touch the wire connectors, please take the necessary measures on the product.
- 6) Be sure to observe the precautions in this manual, otherwise there is a risk of a major injury or accident.
- 7) When wiring, please observe the local regulation.
- 8) To prevent to damage the machine and prevent to machine failure, the product is connected with power lines or large capacity input and output lines and other methods please install proper capacity fuse or other methods of protection circuit.
- 9) Please don't put metal and wire clastic mixed with this product, otherwise it may lead to electric shock, fire, fault.
- 10) Please tighten screw torque according to the rules. If not, it may lead to electric shock and fire.
- 11) In order not to interfere with this products to dissipate heat, please don't plug casing around the cooling vent hole and equipment.
- 12) Please don't connect any unused terminal.
- 13) Please do the cleaning after power off, and use the dry cleaning cloth to wipe away the dirt. Please don't use desiccant, otherwise, it may casue the deformation or discoloration of the product.
- 14) Please don't knock or rub the panel with rigid thing.
- 15) The readers of this manual should have basic knowledge of electrical, control, computer and communications.
- 16) The illustration, example of data and screen in this manual is convenient to understand, instead of guaranteeing the result of the operation.
- 17) In order to use this product with safety for long-term, regular maintenance is necessary. The life of some parts of the equipments are by some restrictions, but the performance of some will change for using many years.
- 18) Without prior notice, the contents of this manual will be change. We hope these is no any loopholes, if you have questions or objections, please contact us.

⚠ Caution of Installation

1. Installation
 - 1) This product is used in the following environmental standards. (IEC61010-1) [Overvoltage category II, class of pollution 2]
 - 2) This product is used in the following scope: environment, temperature, humidity and environmental conditions. Temperature: 0~50°C; humidity: 45~85%RH; Environment condition: Indoor. The altitude is less than 2000m.

3) Please avoid using in the following places:

The place will be dew for changing temperature; with corrosive gases and flammable gas; with vibration and impact; with water, oil, chemicals, smoke and steam facilities with dust, salt, metal powder; and with clutter interference, static electric and magnetic fields, noise; where has air conditioning or heating of air blowing directly to the site; where will be illuminated directly by sunlight; where accumulation of heat will happen caused by radiation.

4) On the occasion of the installation, please consider the following before installation.

In order to prevent heat saturated, please open enough ventilation space. Please consider connections and environment, and ensure that the products below for more than 50mm space. Please avoid to installed over the machine of the calorific value (Such as heaters, transformer, semiconductor operations, the bulk resistance). When the surrounding is more than 50°C, please using the force fan or cooling fans. But don't let cold air blowing directly to the product. In order to improve the anti-interference performance and security, please try to stay away from high pressure machines, power machines to install. Don't install on the same plate with high pressure machine and the product. The distance should be more than 200mm between the product and power line.

⚠ Caution of Connection

2. Cable caution:

- 1) Please use specified compensation wire in the place of TC input; Please use insulated TC if the measured device is heated metal. The influence of external resistance is about 0.3 μV/Ω.
- 2) Please use the cable with small wire resistance in the place of RTD input, and the cable (3 wire) must be no resistance difference. The wire should be run in parallel and the resistance of a single wire should be less than 10 Ω.
- 3) In order to avoid the effect of noise, please put the input signal away from meter cable, power cable, load cable to wiring.
- 4) In order to reduce the power cables and the load power cables on the effect of this product, please use noise filter in the place where easy to effect. You must install it on the grounding of the disk if you use the noise filter, and make the wiring to be shortest between noise filter output side and power connectors. Don't install fuse and switch on the wiring of noise filter output side, otherwise it will reduce the effect of noise filter.
- 5) It takes 5s from input power to output. If there is a place with interlocking actions circuit signal, please use timer relay.
- 6) Please use twisted pair with a shield for analog output line, can also connect the common-mode coil to the front-end of the signal receiving device to suppress line interference if necessary, to ensure the reliability of signal.
- 7) Please use twisted pair with a shield for remote RS485 communication cable, and deal with the shield on the host side earth, to ensure the reliability of signal.
- 8) This product don't have the fuse; please set according to rated voltage 250V, rated current 1A if you need; fuse type: delay fuse.
- 9) Please use suitable screw force and suitable crimping terminal
 Terminal screw size: M3X8 (with 6.8X6.8 square meson)
 Recommended terminal tightening torque: 0.4N.m.
 Proper cables: 0.25 ~ 1.65mm single cable/multiple core cable
- 10) Please don't put the Crimp terminal or bare wire part contact with adjacent connector.

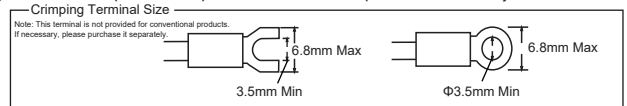

11) The temperature of the cable connected with the terminal shall be at least 70 °C.

II. Model Illustration

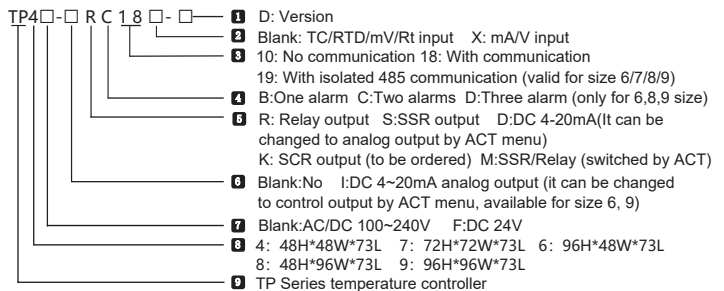

Note: 6, 8 and 9 size with three alarm, have no 4~20mA function. When model selection, please attention it.

III. Models

No.	Model	OUT1 control output			Alarm output			Analog output 4~20mA	Commu- nication RS485	Auxiliary power 24V
		RELAY	SSR	4~20mA	AL1 OUT2	AL2	AL3			
1	TP4-DC18□			●	●	●	⊙	●	●	
2	TP4-DC10□			●	●	●	⊙	●	●	
3	TP4-RC18□	●			●	●				
4	TP4-SC18□		●		●	●				
5	TP4-MC10□	●	●		●	●				
6	TP7-DC18□			●	●	●	⊙	●	●	
7	TP7-DC10□			●	●	●	⊙	●	●	
8	TP7-MC18□	●	●		●	●				
9	TP7-MC10□	●	●		●	●				
10	TP6/8/9-IMC18□	●	●	●	●	●	⊙	●	●	
11	TP6/8/9-IMC10□	●	●	●	●	●	⊙	●	●	
12	TP6/8/9-DC18□		●	●	●	●	⊙	●	●	
13	TP6/8/9-DC10□		●	●	●	●	⊙	●	●	
14	TP6/8/9-MC18□	●	●	●	●	●				
15	TP6/8/9-MC10□	●	●	●	●	●				
16	TP6/8/9-MD18□	●	●	●	●	●				
17	TP6/8/9-MD10□	●	●	●	●	●				

□ Blank: input signal is TC/RTD/Mv/Rt; "X": input signal is 4 ~ 20mA/0 ~ 10V
 ● Standard configuration function
 ⊙ The meter has this function, but it is combined with another function. This series only have one loop 4~20mA output, but the user can modify menu ACT to set it as main control output or analog output.

IV. Specifications

1. Electrical parameters:

Sampling rate	2 times per second
Relay capacity	AC 250V /3A Life of rated resistive load>100,000 times
Power supply	AC/DC 100 ~ 240V (85-265V) ,DC 24V
Power consumption	< 10VA
SSR output	DC 24V pulse voltage, load<30mA
Current output	DC 4 ~ 20mA load<500Ω
Communication port	RS485 port Modbus-RTU protocol
Insulation impedance	Input, output, power to meter cover > 20MΩ

ESD	IEC/EN61000-4-2 Contact ±4KV /Air ±8KV perf.Criteria B
Pulse triap anti-interference	IEC/EN61000-4-4 ±2KV perf.Criteria B
Surge immunity	IEC/EN61000-4-5 ±2KV perf.Criteria B
Voltage drop & short interruption immunity	IEC/EN61000-4-29 0% ~ 70% perf.Criteria B
Isolation voltage	Signal input, output, power: 3000VAC 1min <60V low voltage circuit: AC 500V, 1min
Power failure memory	10 years, times of writing: 1 million times

2. Non Electrical parameters:

Protection level	IP65(IEC60529)
Safety Standard	IEC61010-1 Overvoltage category II, pollution level 2, level II (Enhanced insulation)
Shell material	Shell and panel base frame PC / ABS (flame retardant UL94V-0)
Panel Material	PC(F150/F200)
Total weight	About 400g
Environment	Indoor use only, temperature: 0~50°C no condensation, humidity < 85%RH, altitude<2000m

3. Measured signal specifications :

Input type	Symbol	Measuring range		Resolution	Accuracy(23°C±0.5)	Input impedance/auxiliary current	Comm. parameter code
		°C	°F				
K1		-50 ~ 1200	-60 ~ 2200	1°C	0.5%F.S±3digits	>1MΩ	0
K2		-50.0 ~ 999.9	-60.0 ~ 999.9	0.2°C	0.5%F.S±1°C	>1MΩ	16
J1		0 ~ 1200	0 ~ 2200	1°C	0.5%F.S±3digits	>1MΩ	1
J2		0.0 ~ 999.9	0 ~ 999.9	0.2°C	0.5%F.S±1°C	>1MΩ	17
E1		0 ~ 850	0 ~ 1500	1°C	0.5%F.S±3digits	>1MΩ	2
E2		0.0 ~ 850.0	0 ~ 999.9	0.3°C	0.5%F.S±1°C	>1MΩ	18
T1		-50 ~ 400	-60 ~ 750	1°C	0.5%F.S±3°C	>1MΩ	3
T2		-50.0 ~ 400.0	-60.0 ~ 750.0	0.4°C	0.5%F.S±3°C	>1MΩ	19
B		250 ~ 1800	250 ~ 3200	1°C	1%F.S±2°C	>1MΩ	4
R		-10 ~ 1700	-10 ~ 3000	1°C	1%F.S±2°C	>1MΩ	5
S		-10 ~ 1600	-10 ~ 2900	1°C	1%F.S±2°C	>1MΩ	6
N1		-50 ~ 1200	-60 ~ 2200	1°C	0.5%F.S±1°C	>1MΩ	7
N2		-50.0 ~ 999.9	-60 ~ 999.9	0.2°C	0.5%F.S±1°C	>1MΩ	20
PT100-1		-200.0 ~ 600.0	-200.0 ~ 999.9	0.2°C	0.5%F.S±0.3°C	0.33mA	8
PT100-2		-200 ~ 600	-300 ~ 1100	1°C	0.5%F.S±3digits	0.33mA	21
JPT100-1		-200.0 ~ 500.0	-200.0 ~ 900.0	0.2°C	0.5%F.S±0.3°C	0.33mA	9
JPT100-2		-200 ~ 500	-300 ~ 900	1°C	0.5%F.S±3digits	0.33mA	22
CU50-1		-50.0 ~ 150.0	-60.0 ~ 300.0	0.2°C	0.5%F.S±3°C	0.33mA	10
CU50-2		-50 ~ 150	-60 ~ 300	1°C	0.5%F.S±3°C	0.33mA	23
CU100-1		-50.0 ~ 150.0	-60.0 ~ 300.0	0.2°C	0.5%F.S±1°C	0.33mA	11
CU100-2		-50 ~ 150	-60 ~ 300	1°C	0.5%F.S±3digits	0.33mA	24
0 ~ 50mV		-1999 ~ 9999		12bit	0.5%F.S±3digits	0.33mA	12
0 ~ 400Ω		-1999 ~ 9999		12bit	0.5%F.S±3digits	0.33mA	13
* 4 ~ 20mA		-1999 ~ 9999		12bit	0.5%F.S±3digits	<50Ω	14
* 0 ~ 10V		-1999 ~ 9999		12bit	0.5%F.S±3digits	>1MΩ	15

*: Need to show the input signal requirement when make the order.

3. Isolation diagram:

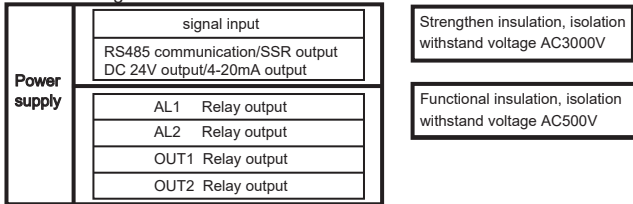

V. Dimension

1. Overall dimensions and hole dimensions

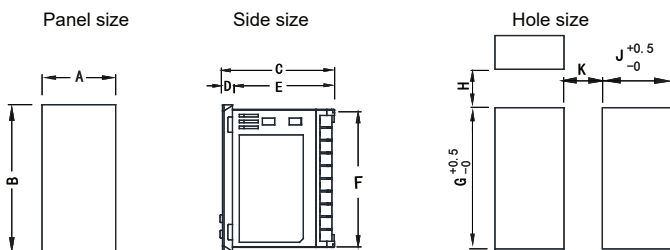

Model	A	B	C	D	E	F	G	H(Min)	J	K(Min)
4:(48*48)	48	48	73	6.5	66.5	44	45	25	45	25
6:(96*48)	48	96	73	6.5	66.5	90	91.5	25	45	25
7:(72*72)	72	72	73	6.5	66.5	66	67.5	25	67.5	25
8:(96*48)	96	48	73	6.5	66.5	44	45	25	91.5	25
9:(96*96)	96	96	73	6.5	66.5	90	91.5	25	91.5	25

2. Installation of fixed bracket (take size 6 as an example)

Installation Diagram

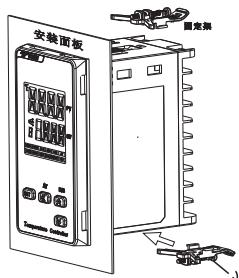

Installation method: You need to embed the instrument in the pre-opened installation hole, then place the fixing bracket on the installation slot of the instrument shell, and push the bracket toward the panel until the instrument is clamped (the operation is as shown in the installation diagram). If it is not tight enough, tighten the fixing screws.

Finished Installation Diagram

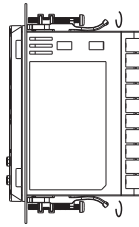

Disassembly method: Loosen the fixed screws first, tilt up the tail of fixed frame, and let the clamping teeth on the lower side of the fixing frame separate from the shell clamping teeth; then exit the fixing frame. Remove the meter from the hole embedded in the meter housing.

3. Installation protection instructions: (take size 6 as an example)

Front protective cover Waterproof gasket Rear protective cover

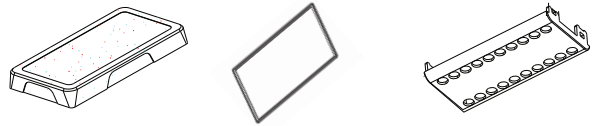

The product is equipped with a front protective cover, a waterproof gasket, and a rear protective cover. Make sure the front panel protection grade reaches IP54 protection level, the front protection cover and waterproof gasket must be installed on the product. The function of the rear protective cover is to prevent the maintenance personnel from accidentally getting an electric shock during maintenance and inspection. After all wiring is completed, the rear protective cover must be covered.

VI. Connection

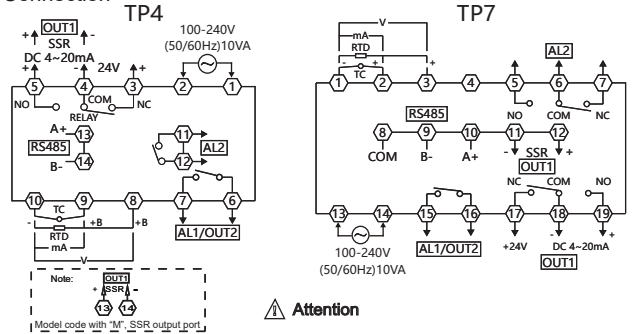

Attention

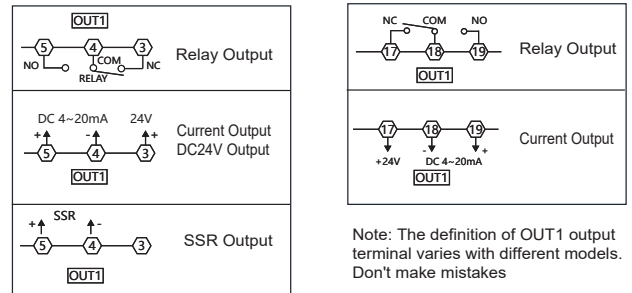

Note: The definition of OUT1 output terminal varies with different models. Don't make mistakes

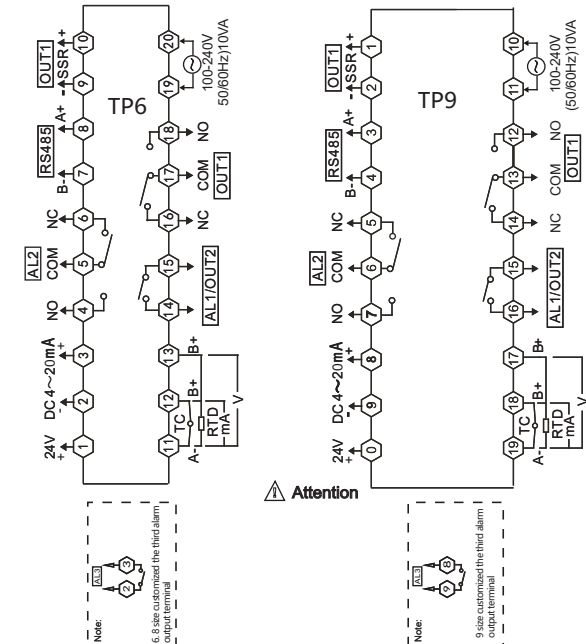

Attention

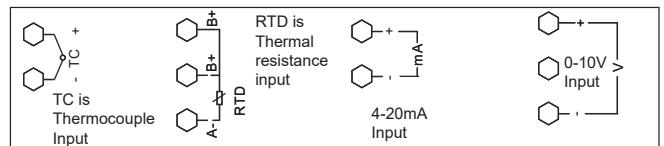

VII. Panel Illustration

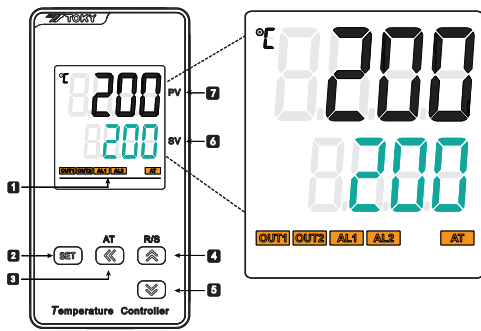

No.	Symbol	Name	Function
1	OUT1	OUT1 (orange)	Main control output indicator, lights on when output ON
	OUT2	OUT2 (orange)	Cooling output indicator, lights on when output ON.
	AL1	Alarm 1# (orange)	1st alarm output indicator, lights on when alarm output, lights off when no alarm output.
	AL2	Alarm 2# (orange)	2nd alarm output indicator, lights on when alarm output, lights off when no alarm output.
	AT	AT indicator (orange)	Auto tune indicator, lights on when it is under auto tune status.
2	SET	SET key	Menu key/confirm key, to enter or exit the modification mode, or to confirm and save the modified parameter.
3	◀	Shift/AT key	Activate key/ shift key/ AT auto tune key (in measure and control mode, long press to enter/exit auto tune)
4	⬆	Add key/R/S	Add key, in measure and control mode, long press to shift RUN/STOP mode, or check the menu in reverse order.
5	⬇	Reduce key	Reduce key, check the menu in sequence
6	SV	Display (green)	Set value / parameter display window, the control is stopped when it displays "STOP"
7	PV	Display (white)	Measured value/ parameter code display window

VIII. Operation process and menu illustration

1. Operation process & method

1). Modify SV Value

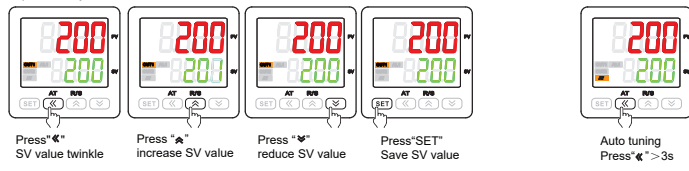

2). Set Common menu

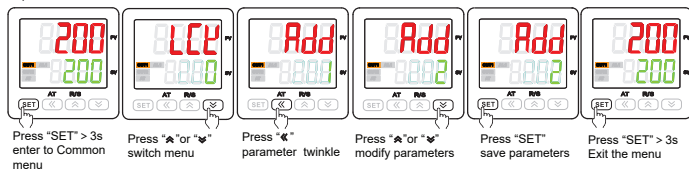

3). Set Advanced menu

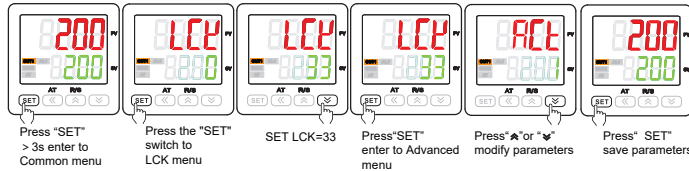

2. Operation examples

1) Example 1, ON/OFF control:

Sensor: K type, measure range -50~1300°C; target temperature: 100°C; control mode: heating; control requirement: ON/OFF control, when current temperature PV reaches 100°C, stop heating; when PV is lower than 98°C, start heating again; control output: relay; alarm: 1 alarm, when PV>110°C, alarm output on; when PV<105°C, alarm output off.

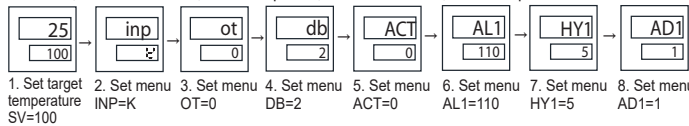

1. Set target temperature SV=100 2. Set menu INP=K 3. Set menu OT=0 4. Set menu DB=2 5. Set menu ACT=0 6. Set menu AL1=110 7. Set menu HY1=5 8. Set menu AD1=1

2) Example 2, PID control:

Sensor: PT100, measure range -200~600°C; target temperature: 150°C; control mode: heating; control requirement: PID control (note: in order to get stable temperature control, please use the auto-tuning function when the controller is powered on for the first time; if the temperature control is stable after the auto tuning, there is no need to repeat this step in the future.); control output: SSR; alarm: 1 alarm, when PV>SV+5°C, alarm output on, when PV<SV-2°C, alarm output off.

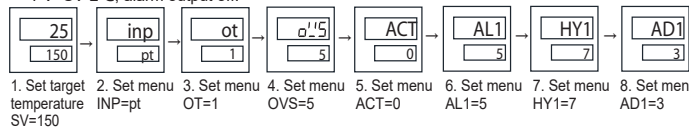

1. Set target temperature SV=150 2. Set menu INP=pt 3. Set menu OT=1 4. Set menu OVS=5 5. Set menu ACT=0 6. Set menu AL1=5 7. Set menu HY1=7 8. Set menu AD1=3

IX. Menu Illustration

□ No matter what model, what control mode it is, it will always display these parameters.
 □ According to different model, control mode, there are some hidden parameters.

1. Regular Menu

No.	Symbol	Name	Illustration	Setting range	Factory setting
1	SP-M	SP-M	Slope display value. When SPRT setting is valid, press SET key can switch to this menu to view the heating rate.	FL ~ FH	
2	AL1	AL1	1st alarm value, note: the minus is dealt as absolute value when it is as a deviation value.	FL ~ FH	10
3	HY1	HY1	1st alarm hysteresis	0 ~ 1000	1

Continued

No.	Symbol	Name	Illustration	Setting range	Factory setting
4	AD1 (1)	AD1 (1)	1st alarm mode, note: when AL1 is used as OUT2 (cooling output), should set the value AD1=0 (close alarm function). When AD1>6, the 2nd alarm function is invalid, see table (1) Alarm logic diagram.	0 ~ 12	3
5	AL2	AL2	2nd alarm value, note: the minus is dealt as absolute value when it is as a deviation value.	FL ~ FH	5
6	HY2	HY2	2nd alarm hysteresis	0 ~ 1000	1
7	AD2 (1)	AD2 (1)	2nd alarm mode, see table(1) Alarm logic diagram.	0 ~ 6	4
8	AL3	AL3	3rd alarm value, note: the minus is dealt as absolute value when it is as a deviation value.	FL ~ FH	200
9	HY3	HY3	3rd alarm hysteresis	0 ~ 1000	1
10	AD3 (1)	AD3 (1)	3rd alarm mode, see table(1) Alarm logic diagram.	0 ~ 6	1
11	PS	PS	Amend value, display value= actual measured value + amend value	FL ~ FH	0
12	INP	INP	Optional input signal. Note: after selecting the signal, please properly set below relevant parameters: SV,AL1,AL2,AL3,HY2,P,OVS,DB.	refer to input signal parameters table (Page 3)	K1
13	OT	OT	Control mode: 0:ON/OFF heating control, relevant parameter: DB. 1: PID heating control, relevant parameters: P, I, D, OVS, CP, ST, SPD, PDC. 2: ON/OFF cooling control, relevant parameter: DB; need to set P1 when it is used for compressor control. 3: PID heating & cooling control/cooling control OUT2 will output through AL1 (relay), relevant parameters: P, I, D, OVS, CP, CP1, PC, DB, ST, SPD, PDC. 4: Over temperature cooling output, relevant parameter: DB. 5: PID cooling, relevant parameter: P, I, D, OVS, CP, ST, SPD, PDC.	0 ~ 5	1
14	A-M	A-M	Auto-manual control switch, AUTO(0): auto control only; MAN(1): manual control only; AM(2): auto-manual shortcut switch	AUTO~AM	AUTO
15	P	P	Proportional band, the smaller the value is, the faster the system responds, otherwise, it is slower. When P=0, no PID control, unit same as PV	0 ~ 9999	30
16	I	I	Integral time, the smaller the value is, the stronger the integral action is, otherwise, it is weaker. When I=0, no integral action, unit: s.	0 ~ 9999	120
17	D	D	Differential time, the greater the value is, the stronger the differential action is, otherwise, it is weaker. When D=0, no differential action. Set D=0 when controlling fast systems, e.g., pressure, speed; unit: s	0 ~ 9999	30
18	OVS	OVS	Overshoot limit, during PID control process, when PV(measured value) > SV(set value) + OVS (overshoot limit), force to close output. The smaller this value is, the smaller the PID adjustment range is, the worse the control stability is. Please set the appropriate value according to the actual situation.	0 ~ 9999	5
19	CP	CP	OUT1 control cycle, 1: SSR control output, 4-200: relay control output. Unit: s	1 ~ 200	20
20	CP1	CP1	OUT2 relay output cycle. Unit: s	4 ~ 200	20
21	PC	PC	OUT2 cooling proportionality coefficient, the higher of value, the stronger of cooling	1 ~ 100	10
22	DB	DB	ON/OFF control hysteresis (positive and negative numbers work the same); when OT=3, it is the dead zone for cooling control (positive and negative numbers work differently); after change the INP setting, please change this parameter according to the decimal point position.	-1000~1000	5
23	LCK	LCK	Lock function. 0001:SV value can't be modified. 0010: menu SV can be checked only, can't be modified. 0033: can enter to advanced menu. 0123: menus reset to factory setting.	0~9999	0

2. Advanced menu illustration

No.	Symbol	Name	Illustration	Setting range	Factory setting
24	ACT	ACT	Control execution mode: 0:relay or SSR control output. 1:SSR control output only. 2: 4~20mA control output, setting should comply with the selected configuration of the meter. 3: 4~20mA retransmission output for size 4/7 products. When this menu is set as 0 or 1, 4-20mA output is used as retransmission output, for size 6/9 products.	0~2 (0~5)	0
25	AE1 (2)	AE1 (2)	1st alarm extensions function, refer to alarm extension function table	0~5	0
26	AE2 (2)	AE2 (2)	2nd alarm extensions function, refer to alarm extension function table	0~5	0
27	AE3 (3)	AE3 (3)	3rd alarm extensions function, refer to alarm extension function table	0~5	0
28	DP	DP	Decimal point setting, a decimal place can be set at most when it is TC & RTD input	0~3	0
29	DTR	DTR	PV fuzzy tracking value, properly set this value on some occasions, it can get a more stable control display value, this value is unrelated with actual measured value. Note: after setting this value, when alarm setting value is equal to SV set value, alarm output operation is subject to actual measured value. Set as 0 to close this function.	0.0 ~ 2.0 (0~20)	1.0 (10)
30	FT	FT	Filter coefficient, the higher of value, the stronger of filter function	0 ~ 255	10
31	UT	UT	Temperature unit: °C: Celsius degrees. °F: Fahrenheit degrees. Note: No unit for linear signal	(25)°C (26)°F	(25)°C
32	SSM	SSM	Panel key switch RUN/STOP operation switch. 0: Close, 1: Open. This setting is only related to panel operation, not related to communication	0 ~ 1	0
33	SLL	SLL	Limit the low limit of target set value. SV beyond this range cannot be modified	FL~FH	
34	SLH	SLH	Limit the high limit of target set value. SV beyond this range cannot be modified	FL~FH	
35	FL	FL	Measure range low limit, the set value must be less than measure range high limit	Refer to measured signal parameter table	-50
36	FH	FH	Measure range high limit, the setting value must be more than measure range low limit.	Refer to measured signal parameter table	1200
37	BRL	BRL	Analog range low limit, note: when this value is higher than analog range high limit, it is reverse analog output.	FL~FH	-50
38	BRH	BRH	Analog range high limit, note: when this value is lower than analog range low limit, it is reverse analog output.	FL~FH	1200
39	OLL	OLL	Output low limit, limit the output low limit current amplitude. Set value must be less than high limit.	-5.0~100.0	0
40	OLH	OLH	Output high limit, limit the output high limit current amplitude. Set value must be greater than low limit.	0.0 ~ 105.0	100.0
41	ST	ST	Auto-tune activation after power-on, 0: work normally after power-on, 1: automatically enter PID parameters auto-tune status after power-on; long press "AT" key to exit auto-tune.	0~1	0
42	SPD	SPD	PID control speed adjustment, option: 0 (N) No. 1 (s) slow, 2 (ss) medium slow, 3(SSS)very slow, 4 (F) fast, 5 (FF) medium fast, 6 (FFF) very fast	0~6	N
43	PDC	PDC	PID algorithm option: 0(FUZ): Advanced fuzzy PID arithmetic. 1(STD): normal PID arithmetic	0~1	FUZ
44	PRS	PRS	Setting parameter saving position: 0 (EEP): EEPROM has power failure protection; 1 (RAM): RAM has no power failure protection	EEP/RAM	EEP

Continued

No.	Symbol	Name	Illustration	Setting range	Factory setting
45	RSS	RUN/STOP saving position: 0 (EEP): EEPROM has power failure protection; 1 (RAM): RAM has no power failure protection		EEP/RAM	EEP
46	PT	Compressor start delay time, unit: s		0~9999	0
47	BAD	Baud 0 (4.8): 4800; 1 (9.6): 9600; 2 (19.2): 19200 3 (38.4): 38400; 4 (57.6): 57600; 5 (115.2): 115200		0~5	9.6
48	ADD	Communication Address		0~247	1
49	PRTY	Communication parity check setting, 0:NO 1:ODD 2:EVEN		0~2	NO
50	DTC	Communication data transport sequence 000; 1st bit function reserved; 2nd bit is byte sequence exchange; 3rd bit function reserved.		Refer to COM. protocol note③	0
51	SPRT	Set value of temperature rise slope, 0 has no such function, unit: °C/minute. When SPRT setting is valid, the PID is running, if the measured value is lower than the given value, the temperature will rise to the given value at the temperature rise speed limit defined by SPRT. Unit: per minute. If SPRT=5, the temperature will rise to the given value at 5 °C per minute.		0~9999	0
52	CAE	User self-calibration enable function, this parameter is only for the input signals except TC/RTD; Y:enable the self-calibration parameters; N: don't use the self-calibration parameters.		0 (N) 1 (Y)	N
53	CAL	Self-calibration low limit input operation, after add the low end signal to the signal input terminal, flash YES to activate, after confirm and display OK, the input signal low end calibration is completed.		YES/OK	YES
54	CAH	Self-calibration high limit input operation, after add the high end signal to the signal input terminal, flash YES to activate, after confirm and display OK, the input signal high end calibration is completed.		YES/OK	YES
55	VER	Software version			

(1) Alarm parameters and output logic diagram:

Symbol description: "▲" means HY, "▲" means alarm value, "△" means SV value

Alarm code	Alarm mode	Alarm output (AL1 & AL3 are independent from each) Image:the hatched section means the alarm action
0	Alarm Close	
1	High limit absolute value alarm	
2	Low limit absolute value alarm	
3	High limit deviation value alarm	
4	Low limit deviation value alarm	
5	High/low limit deviation value alarm	
6	High/low limit interval value alarm	
7	High and low limit absolute value interval alarm	
8	High and low limit deviation value interval alarm	
9	High limit absolute value and low limit deviation value interval alarm	
10	High limit deviation value and low limit absolute value interval alarm	
11	High/low limit absolute value alarm	
12	High/low limit deviation value alarm	

※When the alarm value with deviation alarm is set as a negative number, it will be dealt as an absolute value. 7-12 The following two groups of alarm parameters (AL1 and AL2) are used in combination. AL1 alarm output and AD2 must be set to 0

(2) Alarm extension function table

AE1/AE3 value	Alarm handling method when it displays HHHH/LLLL	Power on, alarm inhibition
0	Alarm status remains the same	Power on, no alarm inhibition (As long as the alarm condition is met, alarm output immediately.)
1	Forced alarm output	
2	Forced alarm close	
3	Alarm status remains the same	Power on, alarm inhibition (After power on and before the PV value reaches the SV for the first time, the alarm will not output. After that alarm work normally)
4	Forced alarm output	
5	Forced alarm close	

X. Key function operation

1. Stop mode

- Under the measure mode, long press " R/S " key to enter the STOP mode, SV window will display "STOP", main control output will stop or keep the minimum output.
- Under STOP mode, long press " R/S " key to exit STOP mode, press " [] " key to modify SV value.
- Under STOP mode, alarm output and retransmission output work normally.

2. PID auto-tune operation:

- Before auto-tune procedure, please switch off the control output load power, or set the meter as STOP mode.
- Before auto-tune procedure, PV value should meet below condition: when it is PID heating control, PV needs to be much smaller than SV; when it is PID cooling control, PV needs to be much larger than SV.
- Before auto-tune procedure, please set a proper alarm value or eliminate the alarm condition, in order to prevent the auto-tune procedure from being affected by alarm output.
- Set PID type and SV value; the factory default setting is fuzzy PID.
- Set as PID control, if there is OLL & OLH output limiting, please set the output to a proper range; factory default setting is OLL=0%, OLH=100%.
- Exit STOP mode, or switch on the load power, immediately long press " AT " key to enter auto-tune mode, then the AT indicator light is on.
- The auto-tune procedure will take some time, in order not to affect auto-tune result, please don't modify the parameters or power-off.
- When AT light goes out, it automatically exits auto-tune mode, PID parameters will be updated automatically, and then the meter will control automatically and exactly.
- During the auto-tune procedure, below actions will cause the termination of the process, long press " AT " key, measure beyond the scope, abnormal display, switch to STOP mode, power-off, etc.
- Note: In the occasions with output limiting operation, sometimes, even if the auto-tune is carried out, the best PID parameters still cannot be obtained.
- Experienced users can set proper PID parameter according to experience.

3. PID heating and proportional cooling control operation

- Set the control mode OT as 3.
- PID heating control acts on OUT1; proportional cooling control acts on OUT2.
- Proportional cooling control OUT2 outputs via AL1 alarm function terminals.
- Please set the cooling start hysteresis DB to a value greater than 5, to ensure the cooling output will not affect the PID heating control.
- Please change the cooling control cycle CP1 and the cooling proportionality coefficient to a proper value.
- When PV value > SV+DB value, the cooling control start to effect; the bigger value of PV, the longer output time of OUT2

4. Auto-manual switch function

- Enter common manual, set parameter A-M as "AM".
- After return back to measure control interface, press " [] " key to switch auto-manual operation.
- When it is switched to manual control, lower line LED will display output percentage: M0-M100 (corresponding to 0%~100%), press Add Key or Reduce Key to modify the output percentage.
- Before the switch from manual control to auto control, in order to ensure the smooth switch, please press Left Key to modify the SV value first.
- After the meter is rebooted, the default setting is manual control and output 0.

5. Fixed manual control function

- Set A-M parameter as "MAN".
- After return back to measure control interface, user can modify output percentage by manual.
- After the meter is powered on again, the manual output percentage can be restored.

6. Linear signal self calibration function operation

- Set up the INP type, and ensure it is one of these input 0 ~ 50mV, RT(0 ~ 400Ω), 4 ~ 20mA and 0 ~ 10V.
- Add the input signal to the correct input channel.
- Enter menu low-limit calibration menu CAL, press " AT " to flash "YES"; and set the input signal to minimum value and input it to the meter.
- When "YES" is flashing, and the minimum value of the signal has been input to the meter, please press " SET " to ensure and save the calibrating value.
- After calibrating low-limit, enter the high-limit calibration menu CAH, and flash "YES".
- Set the input signal to maximum value and input it into the meter; when the "YES" is flashing, press " SET " to ensure and save the calibrating value.
- After calibrating, enter menu CAE, change "N" to "Y" to enable the calibrating value; otherwise, it still use the factory default value.
- The calibrated high-limit input linear signal value should not exceed the input standard value range ±10%.
- If not satisfied with the calibrating result, could calibrate again.

XI. Checking methods of simple fault

Display	Checking methods
LLLL/HHHH	Checks whether the input disconnection and whether normal of FH/ FL value, working environment temperature and whether input signal is selected correctly.
No display when power on	Check whether the voltage is normal; Check whether the contact is bad; internal protection for excessive harmonics in the power grid;
No Output	Check whether the wiring connection is normal; Check whether the contact is bad; ACT/OT menu setting wrong;
No Communication	Check hardware connection, instrument settings and software reading settings; hexadecimal conversion error; Address error; data error

XII. Communication protocol

Meter adopts RS485 Modbus RTU communication protocol. Read function code 0x03 of the holding register in zone 04, write function code 0x10/0x06. Adopt 16 digit CRC check, the meter does not return for error check. The data type is a 16 bit signed or unsigned integer. Data frame format:

Start bit	Data bit	Stop bit	Check bit
1	8	1	None/odd parity/even parity

1. Read register

For example: Host reads integer SV (set value 200)

The address code of SV is 0x2000 ("0x" represents for hexadecimal), because SV data type is a 16-bit integer (2 bytes), seizes 1 data register. The memory code of decimal integer 200 convert to hexadecimal code is 0x00C8. Note: when reading data, should read DP value or confirm DP menu value first to ensure the decimal point position, after that transform the read data to get the actual value. Conversely, it should transform the data to corresponding ratio before writing the data in meter.

Read multi-register	Meter ADD	Function code	Start ADD High bit	Start ADD Low bit	Data byte Length high bit	Data byte Length low bit	CRC Code	CRC Code
Host request	0x01	0x03	0x20	0x00	0x00	0x01	0x8F	0xA
Slave normal answer	0x01	0x03	0x02 bits		0x00	0x08	0xB9	0xD2
Slave abnormal answer	0x01	0x83	0x02 error code		For example: Host request address is 0x2011		0xC0	0xF1

2. Write multi-register

For example: Host use 0x10 function code write SV (SV=150)

ADD code of SV is 0x2000, because SV data type is a 16-bit integer (2 bytes), seizes 1 data register. The decimal integer 150 convert to hexadecimal code is 0x0096. Before writing the data, you should convert the data to the corresponding magnification and then writing the data into the instrument.

Host request (write multi-register)										
Meter ADD	Function code	Start ADD High bit	Start ADD Low bit	Data byte Length high bit	Data byte Length low bit	Data byte Length	Data high bit	Data low bit	CRC code	CRC code
0x01	0x10	0x20	0x00	0x00	0x01	0x02	0x00	0x96	0x07	0xFC
Slave normal answer (write multi-register)										
Meter ADD	Function code	Start ADD High bit	Start ADD Low bit	Data byte length high bit	Data byte length low bit	※CRC low bit	※CRC high bit			
0x01	0x10	0x20	0x00	0x00	0x01	0x0A	0x09			

Host write SV with 0x06 function (set value 150)

Read single register	Meter ADD	Function code	Start ADD High bit	Start ADD Low bit	Data byte Length high bit	Data byte Length low bit	CRC Code	CRC Code
Host request	0x01	0x06	0x20	0x00	0x00	0x96	0x02	0x64
Slave normal answer	0x01	0x06	0x20	0x00	0x00	0x96	0x02	0x64
Slave abnormal answer	0x01	0x86	Function code	0x02 Error Code		0xC3	0xA1	

Handling of abnormal communication:

When abnormal response, put 1 on the highest bit of function code. For example: Host request function code 0x03, and slave response function code should be 0x83.

Error code:

0x01---Illegal function: the function code sent from host is not supported by meter.
0x02---Illegal address: the register address designated by host beyond the address range of meter.
0x03---Illegal data: Date value sent from host exceeds the corresponding data range of meter.

Meter parameters address mapping table

No.	Add(Register No①)	Variable name	Register	R/W	Remark
1	0x2000 (48193)	Setting value SV	1	R/W	
2	0x2001 (48194)	1st alarm value AL1	1	R/W	
3	0x2002 (48195)	1st alarm hysteresis HY1	1	R/W	
4	0x2003 (48196)	2nd alarm valueAL2	1	R/W	
5	0x2004 (48197)	2nd alarm hysteresis HY2	1	R/W	
6	0x2005 (48198)	Display low limit FL	1	R/W	
7	0x2006 (48199)	Display high limit FH	1	R/W	
8	0x2007 (48200)	Analog output low limit BRL	1	R/W	
9	0x2008 (48201)	Analog output high limit BRH	1	R/W	
10	0x2009 (48202)	Control output low limit OLL	1	R/W	
11	0x200A (48203)	Control output high limit OLH	1	R/W	Default 1 decimal point
12	0x200B (48204)	Overshoot limit OVS	1	R/W	
13	0x200C (48205)	Heat & Cool control dead zone DB	1	R/W	
14	0x200D (48206)	Proportional coefficient of cooling PC	1	R/W	Default 1 decimal point
15	0x200E (48207)	Amend value PS	1	R/W	
16	0x200F (48208)	PV fuzzy tracking value DTR	1	R	Engineering work without decimal point
17	0x2010 (48209)	Measured value PV	1	R	
18	0x2011 (48210)	Output percentage MV	1	R/W	0~100
19	0x2012 (48211)	Auto-Manual switch A-M	1	R/W	0:Auto; 1: Manual 2:Auto-Manual switch
20	0x2013 (48212)	the 3rd alarm value AL3	1	R/W	
21	0x2014 (48213)	3rd alarm hysteresis HY3	1	R/W	
22	0x2015 (48214)	Setting value Low limit SLL	1	R/W	
23	0x2016 (48215)	Setting value high limit SLH	1	R/W	
24	0x2017 (48216)	Panel R/S operation switch SSM	1	R/W	
25	0x2018 (48217)	Set the parameter saving position PRS	1	R/W	
26	0x2019 (48218)	RUN/STOP save position RSS	1	R/W	
27	0x201A (48219)	Slope display value SR-M	1	R	
28	0x201B (48220)	Slope temperature rise setting value SPRT	1	R/W	
Reserve					
29	0x2100 (48449)	1st alarm mode AD1	1	R/W	
30	0x2101 (48450)	2nd alarm mode AD2	1	R/W	
31	0x2102 (48451)	1st alarm extended function AE1	1	R/W	
32	0x2103 (48452)	2nd alarm extended function AE2	1	R/W	
33	0x2104 (48453)	Control mode OT	1	R/W	
34	0x2105 (48454)	Output mode ACT	1	R/W	
35	0x2106 (48455)	RUN/STOP operation	1	R/W	1:RUN 2:STP 3:Run auto-tune 4:Stop auto-tune
36	0x2107 (48456)	Decimal pointDP	1	R/W	
37	0x2108 (48457)	Unit display UT	1	R/W	25 (°C) 26 (°F)
38	0x2109 (48458)	Filter constants FT	1	R/W	
39	0x210A (48459)	Proportional coefficient P	1	R/W	No decimal point
40	0x210B (48460)	Integral time I	1	R/W	No decimal point
41	0x210C (48461)	Differential time D	1	R/W	No decimal point
42	0x210D (48462)	Control speed fine-tune SPD	1	R/W	
43	0x210E (48463)	Heating control cycle CP	1	R/W	No decimal point
44	0x210F (48464)	Cooling control cycle CP1	1	R/W	No decimal point
45	0x2110 (48465)	Cooling delay time PT	1	R/W	No decimal point
46	0x2111 (48466)	Optional input signal INP	1	R/W	Refer to signal table
47	0x2112 (48467)	Meter address ADD	1	R/W	
48	0x2113 (48468)	Communication baud rate BAD	1	R	
49	0x2114 (48469)	Com. data transfer sequence DTC	1	R	Note ③
50	0x2115 (48470)	PID arithmetic type PDC	1	R	
51	0x2116 (48471)	Lock LCK	1	R	
52	0x2117 (48472)	Meter name	1	R	
53	0x2118 (48473)	Output state	1	R	Note ②
54	0x2119 (48474)	Parity Check PRTY	1	R	
55	0x211A (48475)	3rd alarm mode AD3	1	R/W	
56	0x211B (48476)	3rd alarm extended function AE3	1	R/W	

R: Read only; R/W: Read & write

Note①: The register number is the address converted to decimal plus 1 and then the register identification code 4 is added in front; for example: the register number of the data address 0x2000 is 8192 + 1 = 8193 and then 4 is added in front, that is, the register number 48193; Related applications can be seen, such as Siemens S7-200 PLC.

Note ②: Measurement status indication. When the data bit is 1, it means execution, and when it is 0, it means no execution.

D8	D7	D6	D5	D4	D3	D2	D1	D0
AL3	STOP	HHHH	LLLL	AT	AL2	AL1	OUT2	OUT1

Note③: DTC communication data transmission sequence description

DTC: Reserve

Byte transfer order: when it is 0, 1, 2, and when it is 1, 2, 1
 Reserve

XIII. Version and Revision History

Date	Version	Revision content
2022.11.18	A/0 Version	1st edition
2023.11.09	A/1 Version	Revision

Manufacturer contact information: Toky Electrical Co., Ltd
 Add: No.8 Minke West Rd, Shiqi District, Zhongshan, Guangdong, CN 528400
 Contact:0760-23371800
 Technical consultation contact: 400-0760-168
 Web:www.toky.com.cn